

37° 扩口接头



FITOK

www.fitok.com

目录

Tube 管管帽组件 - TCA



04

螺母 - N



04

扩口阳螺纹接头 - CM

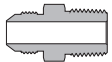

04

扩口活接阳螺纹接头 - CM

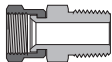

05

扩口阴螺纹接头 - CF



06

扩口活接阴螺纹接头 - CF



06

扩口直通接头 - U



07

大六方扩口直通接头 - HUN



07

扩口变径直通接头 - RA



07

套管 - SL



07

扩口直通穿板接头 - BU

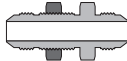

08

穿板锁紧螺母 - BN



08

扩口 Tube 管管帽 - TC



08

扩口 Tube 管堵头 - TP



08

扩口阳螺纹弯头 - LM



09

扩口阳螺纹位置可调弯头 - LP



09

扩口阳螺纹45°弯头 - VM



10

扩口阴螺纹弯头 - LF



10

扩口弯头 - LU



11

扩口活接弯头 - LU



11

支管阳螺纹扩口三通 - TTM



12

支管阳螺纹位置可调扩口三通 - TTP



12

主管阳螺纹扩口三通 - TMT



13

支管阴螺纹扩口三通 - TTF



13

主管阴螺纹扩口三通 - TFT



14

扩口三通 - TTT



14

主管活接扩口三通 - TTT



15

支管活接扩口三通 - TTT



15

扩口四通 - C



15

特征

- ◎ 接头设计和制造遵照标准 SAE J514。
- ◎ 经硬化和抛光的螺纹延长了接头的寿命，避免阴阳螺纹的咬合。
- ◎ 弯头通道圆弧连接，确保流体平稳流动。
- ◎ 不锈钢螺母螺纹镀银，可减少与本体螺纹的摩擦。
- ◎ 每个接头上都刻有尺寸、材料和炉号。
- ◎ 接头拆卸和重新紧固方便。
- ◎ 所有的阳螺纹都戴有塑料保护帽。

技术数据

- ◎ 尺寸范围：1/8" 至 2" 和 3 至 50 mm
- ◎ 螺纹标准：

螺纹类型	参考标准
NPT	ASME B1.20.1, SAE AS71051
统一螺纹 (SAE)	ASME B1.1, SAE J475

- ◎ FITOK 37° 扩口接头工作温度与 FITOK 6D 系列双卡套接头相同。
- ◎ 工作压力：

SAE 名义尺寸	Tube 管 外径 (in.)	37°扩口 端螺纹	SAE 螺纹连接和 穿板连接 (psig/bar)
2	1/8	5/16-24	5000(345)
3	3/16	3/8-24	5000(345)
4	1/4	7/16-20	5000(345)
5	5/16	1/2-20	5000(345)
6	3/8	9/16-18	5000(345)
8	1/2	3/4-16	4500(310)
10	5/8	7/8-14	3500(241)
12	3/4	1 1/16-12	3500(241)
14	7/8	1 3/16-12	3000(207)
16	1	1 5/16-12	3000(207)
20	1 1/4	1 5/8-12	2500(172)
24	1 1/2	1 7/8-12	2000(138)
32	2	2 1/2-12	1500(103)

1. 工作压力仅用于不锈钢材料。关于其他材料的工作压力请联系经授权的代表或 FITOK 集团。
2. 上述工作压力应用四倍安全系数。

材料

材料	棒料	锻件	代号
316 不锈钢	ASTM A276, ASME SA479, EN 1.4401	ASTM A182, ASME SA182, EN 1.4401	SS
铝	ASTM B211	ASTM B247	AL
黄铜	ASTM B16/B453	ASTM B283	B
碳钢	ASTM A108	ASTM A105	CS

订购信息

在基本订购号前面添加材料代码组成完整的订购号。

例：

1. Tube 管外径为 1/4"、螺纹为 1/4 NPT 的 316 不锈钢扩口阳螺纹接头，完整的订购号是：**SS-CM-AN4-NS4**。
2. Tube 管外径为 6 mm 的 316 不锈钢套管，完整的订购号是：**SS-SL-6M**。

扩口操作

Tube 管扩口有两种不同的方式，厚壁管单壁扩口和薄壁管双重壁厚扩口。见下表：

厚壁 Tube 管

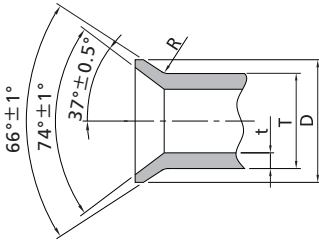

薄壁 Tube 管

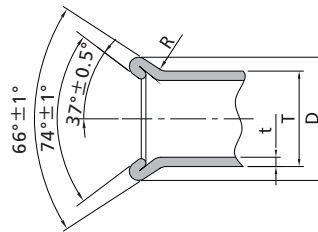

英制 Tube 管			
T-Tube 管 外径 (in.)	尺寸		
	D (mm)	t (in.)	R (mm)
1/4	8.6-9.1	0.020-0.065	0.8
5/16	10.2-10.9	0.020-0.065	0.8
3/8	11.6-12.4	0.020-0.065	1.0
1/2	16.0-16.7	0.028-0.083	1.5
5/8	19.3-20.0	0.035-0.095	1.5
3/4	23.3-24.1	0.035-0.109	2.0
7/8	26.4-27.1	0.035-0.109	2.0
1	29.7-30.4	0.035-0.120	2.3
1 1/4	37.5-38.3	0.049-0.120	2.3
1 1/2	43.2-43.9	0.049-0.120	2.8
2	59.2-59.9	0.065-0.134	2.8

公制 Tube 管			
T-Tube 管 外径 (mm)	尺寸		
	D (mm)	t (mm)	R (mm)
6	8.4-9.2	0.5-1.5	0.8
8	10.1-10.8	0.5-1.5	0.8
10	12.0-12.5	0.5-1.5	1.0
12	16.0-16.7	1.0-2.0	1.5
14	18.8-19.5	1.0-2.5	1.5
15	19.4-20.0	1.0-2.5	1.5
16	19.4-20.0	1.0-2.5	1.5
18	23.5-24.0	1.0-3.0	2.0
20	24.0-24.5	1.0-3.0	2.0
22	26.2-27.2	1.0-3.0	2.0
25	29.5-30.2	1.0-3.0	2.3
30	37.4-38.0	1.5-3.0	2.3
32	37.6-38.3	1.5-3.0	2.3
38	43.5-44.5	1.5-3.0	2.8
50	58.9-59.6	1.5-3.5	2.8

安装说明

1. 切割适当长度的管子。
2. 将管子插入螺母和套管内。
3. 将管子扩口成 37° 尺寸，尺寸应符合 SAE J533。见扩口操作。
4. 用手拧紧螺母。
5. 牢牢固定接头本体，用扳手将螺母拧紧 1/4 圈。



步骤 1

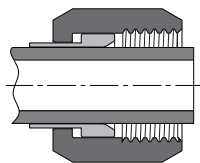

步骤 2

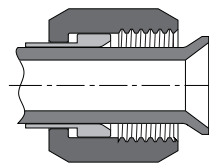

步骤 3

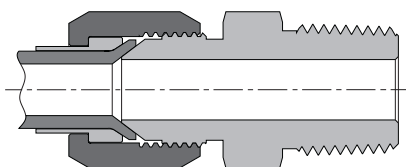

步骤 4

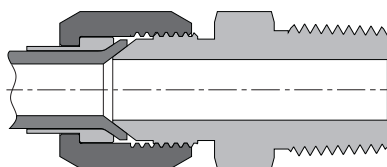

步骤 5

警告：

- ⊙ 不要在系统有压力的时候松开和紧固接头。
- ⊙ 在锥管螺纹上始终使用适当的螺纹密封剂。

Tube 管帽组件

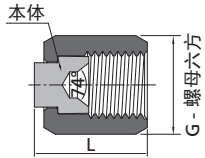

SAE 070112A					
Tube 管外径		基本订购号	尺寸, in. (mm)		
in.	mm		L	G	
1/8	3	-TCA-AN2	0.60 (15.3)	0.37 (9.5)	
3/16	4	-TCA-AN3	0.66 (16.8)	0.44 (11.1)	
1/4	6	-TCA-AN4	0.67 (17.1)	0.56 (14.3)	
5/16	8	-TCA-AN5	0.77 (19.5)	0.63 (15.9)	
3/8	10	-TCA-AN6	0.81 (20.5)	0.69 (17.5)	
1/2	12	-TCA-AN8	0.94 (23.9)	0.87 (22.2)	
5/8	16	-TCA-AN10	1.07 (27.1)	1.00 (25.4)	
3/4	18	-TCA-AN12	1.24 (31.6)	1.25 (31.8)	
7/8	22	-TCA-AN14	1.26 (32.0)	1.37 (34.9)	
1	25	-TCA-AN16	1.29 (32.8)	1.50 (38.1)	
1 1/4	32	-TCA-AN20	1.39 (35.4)	2.00 (50.8)	
1 1/2	38	-TCA-AN24	1.70 (43.2)	2.25 (57.2)	
2	50	-TCA-AN32	2.07 (52.6)	2.87 (73.0)	

螺母

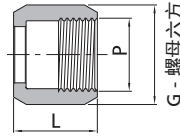

SAE 070110					
Tube 管外径		P-SAE/MS 螺纹尺寸	基本订购号	尺寸, in. (mm)	
in.	mm			L	G
1/8	3	5/16-24	-N-AN2	0.55 (14.0)	0.37 (9.5)
3/16	4	3/8-24	-N-AN3	0.61 (15.5)	0.44 (11.1)
1/4	6	7/16-20	-N-AN4	0.62 (15.8)	0.56 (14.3)
5/16	8	1/2-20	-N-AN5	0.68 (17.3)	0.63 (15.9)
3/8	10	9/16-18	-N-AN6	0.73 (18.5)	0.69 (17.5)
1/2	12	3/4-16	-N-AN8	0.85 (21.6)	0.87 (22.2)
5/8	16	7/8-14	-N-AN10	0.98 (24.9)	1.00 (25.4)
3/4	18	1 1/16-12	-N-AN12	1.03 (26.2)	1.25 (31.8)
7/8	22	1 3/16-12	-N-AN14	1.09 (27.7)	1.37 (34.9)
1	25	1 5/16-12	-N-AN16	1.13 (28.7)	1.50 (38.1)
1 1/4	32	1 5/8-12	-N-AN20	1.23 (31.2)	2.00 (50.8)
1 1/2	38	1 7/8-12	-N-AN24	1.42 (36.1)	2.25 (57.2)
2	50	2 1/2-12	-N-AN32	1.75 (44.5)	2.87 (73.0)

扩口阳螺纹接头

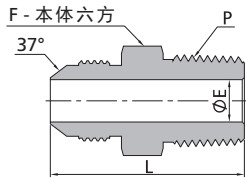

SAE 070102						
Tube 管外径		P-NPT 尺寸	基本订购号	尺寸, in. (mm)		
in.	mm			L	E	F
1/8	3	1/8	-CM-AN2-NS2	1.11 (28.2)	0.06 (1.6)	0.44 (11.1)
3/16	4	1/8	-CM-AN3-NS2	1.14 (29.0)	0.13 (3.2)	0.44 (11.1)
1/4	6	1/8	-CM-AN4-NS2	1.22 (31.0)	0.17 (4.4)	0.50 (12.7)
1/4	6	1/4	-CM-AN4-NS4	1.42 (36.0)	0.17 (4.4)	0.56 (14.3)
1/4	6	1/2	-CM-AN4-NS8	1.68 (42.7)	0.17 (4.4)	0.87 (22.2)
5/16	8	1/8	-CM-AN5-NS2	1.22 (31.0)	0.19 (4.8)	0.56 (14.3)
5/16	8	1/4	-CM-AN5-NS4	1.42 (36.1)	0.24 (6.0)	0.56 (14.3)
3/8	10	1/8	-CM-AN6-NS2	1.25 (31.8)	0.19 (4.8)	0.63 (15.9)
3/8	10	1/4	-CM-AN6-NS4	1.43 (36.3)	0.28 (7.1)	0.63 (15.9)
3/8	10	3/8	-CM-AN6-NS6	1.43 (36.3)	0.30 (7.5)	0.75 (19.1)
3/8	10	1/2	-CM-AN6-NS8	1.67 (42.5)	0.30 (7.5)	0.87 (22.2)
1/2	12	1/4	-CM-AN8-NS4	1.53 (38.9)	0.28 (7.1)	0.81 (20.6)
1/2	12	3/8	-CM-AN8-NS6	1.53 (38.9)	0.39 (9.9)	0.81 (20.6)
1/2	12	1/2	-CM-AN8-NS8	1.79 (45.5)	0.39 (9.9)	0.87 (22.2)
1/2	12	3/4	-CM-AN8-NS12	1.85 (47.0)	0.39 (9.9)	1.13 (28.6)
5/8	16	3/8	-CM-AN10-NS6	1.70 (43.1)	0.38 (9.6)	0.94 (23.8)
5/8	16	1/2	-CM-AN10-NS8	1.89 (48.0)	0.48 (12.3)	0.94 (23.8)
5/8	16	3/4	-CM-AN10-NS12	1.95 (49.5)	0.48 (12.3)	1.13 (28.6)
3/4	18	3/4	-CM-AN12-NS12	2.06 (52.3)	0.61 (15.5)	1.13 (28.6)
3/4	18	1	-CM-AN12-NS16	2.25 (57.1)	0.61 (15.5)	1.37 (34.9)
7/8	22	3/4	-CM-AN14-NS12	2.09 (53.1)	0.62 (15.7)	1.25 (31.8)
1	25	3/4	-CM-AN16-NS12	2.11 (53.5)	0.62 (15.7)	1.37 (34.9)
1	25	1	-CM-AN16-NS16	2.30 (58.4)	0.85 (21.5)	1.37 (34.9)
1 1/4	32	1	-CM-AN20-NS16	2.42 (61.5)	0.88 (22.4)	1.69 (42.9)
1 1/4	32	1 1/4	-CM-AN20-NS20	2.45 (62.2)	1.08 (27.5)	1.69 (42.9)
1 1/2	38	1 1/4	-CM-AN24-NS20	2.68 (68.1)	1.13 (28.6)	2.00 (50.8)
1 1/2	38	1 1/2	-CM-AN24-NS24	2.68 (68.1)	1.30 (33.0)	2.00 (50.8)
2	50	2	-CM-AN32-NS32	3.11 (79.0)	1.77 (45.0)	2.63 (66.7)

扩口阳螺纹接头

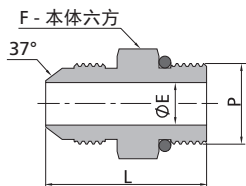

SAE 070120

Tube 管外径		P-SAE 名义尺寸	P-SAE/MS 螺纹尺寸	基本订购号	尺寸, in. (mm)		
in.	mm				L	E	F
1/8	3	2	5/16-24	-CM-AN2-ST5	1.06 (26.9)	0.06 (1.6)	0.44 (11.1)
3/16	4	3	3/8-24	-CM-AN3-ST6	1.10 (27.9)	0.13 (3.2)	0.50 (12.7)
1/4	6	4	7/16-20	-CM-AN4-ST7	1.23 (31.2)	0.17 (4.4)	0.56 (14.3)
1/4	6	5	1/2-20	-CM-AN4-ST8	1.23 (31.2)	0.17 (4.4)	0.63 (15.9)
1/4	6	6	9/16-18	-CM-AN4-ST9	1.30 (33.0)	0.17 (4.4)	0.69 (17.5)
1/4	6	8	3/4-16	-CM-AN4-ST12	1.37 (34.8)	0.17 (4.4)	0.87 (22.2)
5/16	8	5	1/2-20	-CM-AN5-ST8	1.23 (31.2)	0.24 (6.0)	0.63 (15.9)
3/8	10	6	9/16-18	-CM-AN6-ST9	1.30 (33.0)	0.30 (7.5)	0.69 (17.5)
3/8	10	8	3/4-16	-CM-AN6-ST12	1.38 (35.1)	0.30 (7.5)	0.87 (22.2)
3/8	10	10	7/8-14	-CM-AN6-ST14	1.50 (38.1)	0.30 (7.5)	1.00 (25.4)
1/2	12	6	9/16-18	-CM-AN8-ST9	1.44 (36.6)	0.30 (7.5)	0.81 (20.6)
1/2	12	8	3/4-16	-CM-AN8-ST12	1.48 (37.6)	0.39 (9.9)	0.87 (22.2)
1/2	12	10	7/8-14	-CM-AN8-ST14	1.60 (40.6)	0.39 (9.9)	1.00 (25.4)
1/2	12	12	1 1/16-12	-CM-AN8-ST17	1.76 (44.7)	0.39 (9.9)	1.25 (31.8)
5/8	16	8	3/4-16	-CM-AN10-ST12	1.60 (40.6)	0.42 (10.7)	0.94 (23.8)
5/8	16	10	7/8-14	-CM-AN10-ST14	1.70 (43.2)	0.48 (12.3)	1.00 (25.4)
5/8	16	12	1 1/16-12	-CM-AN10-ST17	1.86 (47.2)	0.48 (12.3)	1.25 (31.8)
3/4	18	8	3/4-16	-CM-AN12-ST12	1.78 (45.2)	0.42 (10.7)	1.25 (31.7)
3/4	18	10	7/8-14	-CM-AN12-ST14	1.83 (46.4)	0.50 (12.7)	1.25 (31.7)
3/4	18	12	1 1/16-12	-CM-AN12-ST17	1.97 (50.0)	0.61 (15.5)	1.25 (31.8)
3/4	18	16	1 5/16-12	-CM-AN12-ST21	2.00 (50.8)	0.61 (15.5)	1.50 (38.1)
7/8	22	14	1 3/16-12	-CM-AN14-ST19	1.99 (50.5)	0.72 (18.3)	1.37 (34.9)
7/8	22	16	1 5/16-12	-CM-AN14-ST21	2.02 (51.3)	0.72 (18.3)	1.50 (38.1)
1	25	12	1 1/16-12	-CM-AN16-ST17	2.01 (51.1)	0.66 (16.7)	1.37 (34.9)
1	25	14	1 3/16-12	-CM-AN16-ST19	2.04 (51.8)	0.72 (18.3)	1.37 (34.9)
1	25	16	1 5/16-12	-CM-AN16-ST21	2.04 (51.8)	0.85 (21.5)	1.50 (38.1)

扩口活接阳螺纹接头

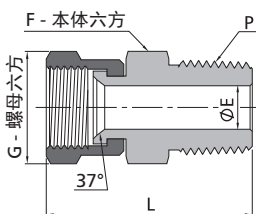

Tube 管外径		P-NPT 尺寸	基本订购号	尺寸, in. (mm)			
in.	mm			L	E	G	F
1/8	3	1/8	-CM-AS2-NS2	1.18 (30.0)	0.06 (1.6)	0.44 (11.1)	0.44 (11.1)
3/16	4	1/8	-CM-AS3-NS2	1.26 (32.0)	0.13 (3.2)	0.50 (12.7)	0.44 (11.1)
1/4	6	1/8	-CM-AS4-NS2	1.35 (34.2)	0.17 (4.4)	0.56 (14.3)	0.50 (12.7)
5/16	8	1/8	-CM-AS5-NS2	1.38 (35.0)	0.24 (6.0)	0.63 (15.9)	0.56 (14.3)
3/8	10	1/4	-CM-AS6-NS4	1.58 (40.2)	0.30 (7.5)	0.69 (17.5)	0.63 (15.9)
1/2	12	3/8	-CM-AS8-NS6	1.68 (42.7)	0.39 (9.9)	0.87 (22.2)	0.81 (20.6)
5/8	16	1/2	-CM-AS10-NS8	2.02 (51.3)	0.48 (12.3)	1.00 (25.4)	0.94 (23.8)
3/4	18	3/4	-CM-AS12-NS12	2.15 (54.5)	0.61 (15.5)	1.25 (31.8)	1.25 (31.7)
7/8	22	3/4	-CM-AS14-NS12	2.20 (56.0)	0.71 (18.0)	1.37 (34.9)	1.25 (31.8)
1	25	1	-CM-AS16-NS16	2.51 (63.7)	0.85 (21.5)	1.50 (38.1)	1.37 (34.9)
1 1/4	32	1 1/4	-CM-AS20-NS20	2.71 (68.9)	1.08 (27.5)	2.00 (50.8)	1.69 (42.9)
1 1/2	38	1 1/2	-CM-AS24-NS24	3.06 (77.6)	1.30 (33.0)	2.25 (57.2)	2.00 (50.8)
2	50	2	-CM-AS32-NS32	3.66 (92.9)	1.77 (45.0)	2.87 (73.0)	2.63 (66.7)

扩口阴螺纹接头

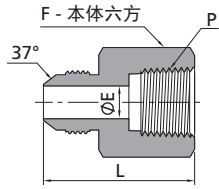

SAE 070103							
Tube 管外径		P-NPT 尺寸	基本订购号	尺寸, in. (mm)			
in.	mm			L	E	F	
1/8	3	1/8	-CF-AN2-NS2	1.12 (28.4)	0.06 (1.6)	0.56 (14.3)	
3/16	4	1/8	-CF-AN3-NS2	1.13 (28.7)	0.13 (3.2)	0.56 (14.3)	
1/4	6	1/8	-CF-AN4-NS2	1.19 (30.2)	0.17 (4.4)	0.56 (14.3)	
1/4	6	1/4	-CF-AN4-NS4	1.39 (35.3)	0.17 (4.4)	0.75 (19.1)	
5/16	8	1/8	-CF-AN5-NS2	1.17 (29.7)	0.24 (6.0)	0.56 (14.3)	
5/16	8	1/4	-CF-AN5-NS4	1.39 (35.3)	0.24 (6.0)	0.75 (19.1)	
3/8	10	1/4	-CF-AN6-NS4	1.40 (35.6)	0.30 (7.5)	0.75 (19.1)	
3/8	10	3/8	-CF-AN6-NS6	1.46 (37.1)	0.30 (7.5)	0.87 (22.2)	
1/2	12	3/8	-CF-AN8-NS6	1.56 (39.6)	0.39 (9.9)	0.87 (22.2)	
1/2	12	1/2	-CF-AN8-NS8	1.80 (45.6)	0.39 (9.9)	1.25 (31.7)	
5/8	16	1/2	-CF-AN10-NS8	1.89 (48.0)	0.48 (12.3)	1.25 (31.7)	
3/4	18	1/2	-CF-AN12-NS8	2.05 (52.1)	0.61 (15.5)	1.25 (31.7)	
3/4	18	3/4	-CF-AN12-NS12	2.06 (52.3)	0.61 (15.5)	1.37 (34.9)	
7/8	22	3/4	-CF-AN14-NS12	2.06 (52.3)	0.72 (18.3)	1.37 (34.9)	
1	25	1	-CF-AN16-NS16	2.35 (59.7)	0.85 (21.5)	1.63 (41.3)	
1 1/4	32	1 1/4	-CF-AN20-NS20	2.49 (63.2)	1.08 (27.5)	2.00 (50.8)	
1 1/2	38	1 1/2	-CF-AN24-NS24	2.62 (66.5)	1.30 (33.0)	2.37 (60.3)	
2	50	2	-CF-AN32-NS32	2.97 (75.4)	1.77 (45.0)	2.87 (73.0)	

扩口活接阴螺纹接头

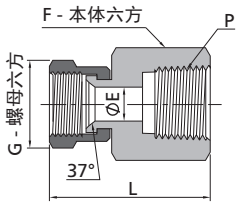

Tube 管外径		P-NPT 尺寸	基本订购号	尺寸, in. (mm)			
in.	mm			L	E	G	F
1/8	3	1/8	-CF-AS2-NS2	1.42 (36.1)	0.06 (1.6)	0.44 (11.1)	0.56 (14.3)
3/16	4	1/8	-CF-AS3-NS2	1.47 (37.3)	0.13 (3.2)	0.50 (12.7)	0.56 (14.3)
1/4	6	1/8	-CF-AS4-NS2	1.56 (39.7)	0.17 (4.4)	0.56 (14.3)	0.56 (14.3)
5/16	8	1/8	-CF-AS5-NS2	1.59 (40.5)	0.24 (6.0)	0.63 (15.9)	0.56 (14.3)
3/8	10	1/4	-CF-AS6-NS4	1.80 (45.8)	0.30 (7.5)	0.69 (17.5)	0.75 (19.1)
1/2	12	3/8	-CF-AS8-NS6	1.85 (47.0)	0.39 (9.9)	0.87 (22.2)	0.87 (22.2)
5/8	16	1/2	-CF-AS10-NS8	2.03 (51.6)	0.48 (12.3)	1.00 (25.4)	1.25 (31.7)
3/4	18	3/4	-CF-AS12-NS12	2.62 (66.6)	0.61 (15.5)	1.25 (31.8)	1.37 (34.9)
7/8	22	3/4	-CF-AS14-NS12	2.67 (67.8)	0.71 (18.0)	1.37 (34.9)	1.37 (34.9)
1	25	1	-CF-AS16-NS16	2.89 (73.5)	0.85 (21.5)	1.50 (38.1)	1.63 (41.3)
1 1/4	32	1 1/4	-CF-AS20-NS20	3.07 (78.1)	1.08 (27.5)	2.00 (50.8)	2.00 (50.8)
1 1/2	38	1 1/2	-CF-AS24-NS24	3.41 (86.7)	1.30 (33.0)	2.37 (60.3)	2.37 (60.3)
2	50	2	-CF-AS32-NS32	3.52 (89.3)	1.77 (45.0)	2.87 (73.0)	2.63 (66.7)

扩口直通接头

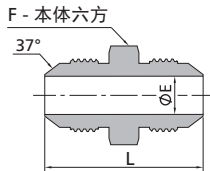

SAE 070101

Tube 管外径		基本 订购号	尺寸, in. (mm)		
in.	mm		L	E	F
1/8	3	-U-AN2	1.17 (29.7)	0.06 (1.6)	0.44 (11.1)
3/16	4	-U-AN3	1.23 (31.2)	0.13 (3.2)	0.44 (11.1)
1/4	6	-U-AN4	1.37 (34.8)	0.17 (4.4)	0.50 (12.7)
5/16	8	-U-AN5	1.37 (34.8)	0.24 (6.0)	0.56 (14.3)
3/8	10	-U-AN6	1.41 (35.8)	0.30 (7.5)	0.63 (15.9)
1/2	12	-U-AN8	1.62 (41.1)	0.39 (9.9)	0.81 (20.6)
5/8	16	-U-AN10	1.88 (47.8)	0.48 (12.3)	0.94 (23.8)
3/4	18	-U-AN12	2.16 (54.9)	0.61 (15.5)	1.25 (31.7)
7/8	22	-U-AN14	2.21 (56.1)	0.72 (18.3)	1.25 (31.8)
1	25	-U-AN16	2.25 (57.2)	0.85 (21.5)	1.37 (34.9)
1 1/4	32	-U-AN20	2.43 (61.7)	1.08 (27.5)	1.69 (42.9)
1 1/2	38	-U-AN24	2.75 (69.8)	1.30 (33.0)	2.00 (50.8)
2	50	-U-AN32	3.40 (86.4)	1.77 (45.0)	2.63 (66.7)

大六方扩口直通接头

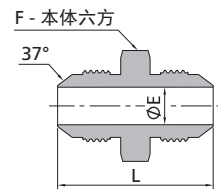

SAE 070119

Tube 管外径		基本 订购号	尺寸, in. (mm)		
in.	mm		L	E	F
1/8	3	-HUN-AN2	1.17 (29.7)	0.06 (1.6)	0.56 (14.3)
3/16	4	-HUN-AN3	1.23 (31.2)	0.13 (3.2)	0.63 (15.9)
1/4	6	-HUN-AN4	1.37 (34.8)	0.17 (4.4)	0.69 (17.5)
5/16	8	-HUN-AN5	1.37 (34.8)	0.24 (6.0)	0.75 (19.1)
3/8	10	-HUN-AN6	1.41 (35.8)	0.30 (7.5)	0.81 (20.6)
1/2	12	-HUN-AN8	1.62 (41.1)	0.39 (9.9)	1.00 (25.4)
5/8	16	-HUN-AN10	1.88 (47.8)	0.48 (12.3)	1.25 (31.7)
3/4	18	-HUN-AN12	2.16 (54.9)	0.61 (15.5)	1.37 (34.9)
7/8	22	-HUN-AN14	2.21 (56.1)	0.72 (18.3)	1.50 (38.1)
1	25	-HUN-AN16	2.25 (57.2)	0.85 (21.5)	1.63 (41.3)
1 1/4	32	-HUN-AN20	2.43 (61.7)	1.08 (27.5)	1.87 (47.6)
1 1/2	38	-HUN-AN24	2.75 (69.8)	1.30 (33.0)	2.13 (54.0)
2	50	-HUN-AN32	3.40 (86.4)	1.77 (45.0)	2.75 (69.9)

扩口变径直通接头

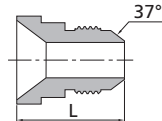

SAE 070123

Tube 管外径		基本 订购号	L in.(mm)
in.-mm	in.-mm		
3/8-10	1/4-6	-RA-AN6-AN4	0.97 (24.6)
1/2-12	1/4-6	-RA-AN8-AN4	1.00 (25.4)
1/2-12	3/8-10	-RA-AN8-AN6	1.00 (25.4)
5/8-16	1/4-6	-RA-AN10-AN4	1.03 (26.2)
5/8-16	3/8-10	-RA-AN10-AN6	1.03 (26.2)
3/4-18	1/4-6	-RA-AN12-AN4	1.09 (27.7)
3/4-18	3/8-10	-RA-AN12-AN6	1.09 (27.7)
3/4-18	1/2-12	-RA-AN12-AN8	1.19 (30.2)
7/8-22	3/8-10	-RA-AN14-AN6	1.13 (28.7)
7/8-22	5/8-16	-RA-AN14-AN10	1.33 (33.7)
1-25	1/4-6	-RA-AN16-AN4	1.22 (31.0)
1-25	3/8-10	-RA-AN16-AN6	1.22 (31.0)
1-25	1/2-12	-RA-AN16-AN8	1.27 (32.3)
1-25	5/8-16	-RA-AN16-AN10	1.38 (35.1)
1-25	3/4-18	-RA-AN16-AN12	1.47 (37.3)
1 1/4-32	3/4-18	-RA-AN20-AN12	1.53 (38.8)
1 1/4-32	1-25	-RA-AN20-AN16	1.59 (40.3)
1 1/2-38	1/2-12	-RA-AN24-AN8	1.56 (39.6)
1 1/2-38	3/4-18	-RA-AN24-AN12	1.63 (41.4)
1 1/2-38	1-25	-RA-AN24-AN16	1.63 (41.4)
2-50	1 1/2-38	-RA-AN32-AN24	1.91 (48.5)

套管

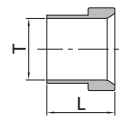

SAE 070115

Tube 管外径		基本 订购号		L in.(mm)
in.	mm	in.	mm	
1/8	3	-SL-AN2	-SL-AN3M	0.34 (8.6)
3/16	4	-SL-AN3	-SL-AN4M	0.34 (8.6)
1/4	6	-SL-AN4	-SL-AN6M	0.41 (10.4)
5/16	8	-SL-AN5	-SL-AN8M	0.44 (11.2)
3/8	10	-SL-AN6	-SL-AN10M	0.50 (12.7)
1/2	12	-SL-AN8	-SL-AN12M	0.56 (14.2)
5/8	16	-SL-AN10	-SL-AN16M	0.66 (16.8)
3/4	18	-SL-AN12	-SL-AN18M	0.68 (17.3)
7/8	22	-SL-AN14	-SL-AN22M	0.76 (19.3)
1	25	-SL-AN16	-SL-AN25M	0.78 (19.8)
1 1/4	32	-SL-AN20	-SL-AN32M	0.91 (23.1)
1 1/2	38	-SL-AN24	-SL-AN38M	1.12 (28.4)
2	50	-SL-AN32	-SL-AN50M	1.19 (30.2)

扩口直通穿板接头

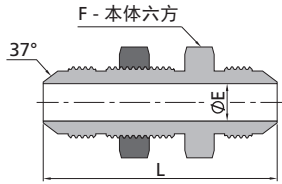

SAE 070601					
Tube 管外径		基本 订购号	尺寸, in. (mm)		
in.	mm		L	E	F
3/16	4	-BU-AN3	1.90 (48.3)	0.13 (3.2)	0.63 (15.9)
1/4	6	-BU-AN4	2.07 (52.6)	0.17 (4.4)	0.69 (17.5)
5/16	8	-BU-AN5	2.07 (52.6)	0.24 (6.0)	0.75 (19.1)
3/8	10	-BU-AN6	2.18 (55.4)	0.30 (7.5)	0.81 (20.6)
1/2	12	-BU-AN8	2.44 (62.0)	0.39 (9.9)	1.00 (25.4)
5/8	16	-BU-AN10	2.74 (69.6)	0.48 (12.3)	1.25 (31.7)
3/4	18	-BU-AN12	3.09 (78.5)	0.61 (15.5)	1.37 (34.9)
7/8	22	-BU-AN14	3.12 (79.2)	0.72 (18.3)	1.50 (38.1)
1	25	-BU-AN16	3.14 (79.8)	0.85 (21.5)	1.63 (41.3)
1 1/4	32	-BU-AN20	3.31 (84.1)	1.08 (27.5)	1.87 (47.6)
1 1/2	38	-BU-AN24	3.52 (89.4)	1.30 (33.0)	2.13 (54.0)
2	50	-BU-AN32	4.20 (106.7)	1.77 (45.0)	2.75 (69.9)

扩口 Tube 管管帽

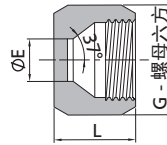

SAE 070112					
Tube 管外径		基本 订购号	尺寸, in. (mm)		
in.	mm		L	E	G
1/8	3	-TC-AN2	0.50 (12.7)	0.06 (1.6)	0.37 (9.5)
3/16	4	-TC-AN3	0.56 (14.3)	0.13 (3.2)	0.44 (11.1)
1/4	6	-TC-AN4	0.59 (15.1)	0.17 (4.4)	0.56 (14.3)
5/16	8	-TC-AN5	0.61 (15.5)	0.24 (6.0)	0.63 (15.9)
3/8	10	-TC-AN6	0.63 (15.9)	0.30 (7.5)	0.69 (17.5)
1/2	12	-TC-AN8	0.75 (19.1)	0.39 (9.9)	0.87 (22.2)
5/8	16	-TC-AN10	0.84 (21.4)	0.48 (12.3)	1.00 (25.4)
3/4	18	-TC-AN12	0.91 (23.0)	0.61 (15.5)	1.25 (31.8)
7/8	22	-TC-AN14	0.97 (24.6)	0.72 (18.3)	1.37 (34.9)
1	25	-TC-AN16	1.02 (25.8)	0.85 (21.5)	1.50 (38.1)
1 1/4	32	-TC-AN20	1.06 (27.0)	1.08 (27.5)	2.00 (50.8)
1 1/2	38	-TC-AN24	1.19 (30.2)	1.30 (33.0)	2.25 (57.2)
2	50	-TC-AN32	1.44 (36.5)	1.77 (45.0)	2.87 (73.0)

穿板锁紧螺母

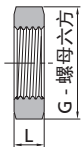

SAE 070118				
Tube 管外径		基本 订购号	尺寸, in. (mm)	
in.	mm		L	G
3/16	4	-BN-AN3	0.22 (5.6)	0.63 (15.9)
1/4	6	-BN-AN4	0.28 (7.1)	0.69 (17.5)
5/16	8	-BN-AN5	0.28 (7.1)	0.75 (19.1)
3/8	10	-BN-AN6	0.27 (6.9)	0.81 (20.6)
1/2	12	-BN-AN8	0.31 (7.9)	1.00 (25.4)
5/8	16	-BN-AN10	0.36 (9.1)	1.13 (28.6)
3/4	18	-BN-AN12	0.41 (10.4)	1.37 (34.9)
7/8	22	-BN-AN14	0.41 (10.4)	1.50 (38.1)
1	25	-BN-AN16	0.41 (10.4)	1.63 (41.3)
1 1/4	32	-BN-AN20	0.41 (10.4)	1.87 (47.6)
1 1/2	38	-BN-AN24	0.41 (10.4)	2.13 (54.0)
2	50	-BN-AN32	0.41 (10.4)	2.75 (69.9)

扩口 Tube 管堵头

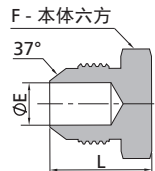

SAE 070109					
Tube 管外径		基本 订购号	尺寸, in. (mm)		
in.	mm		L	E	F
1/8	3	-TP-AN2	0.70 (17.8)	0.06 (1.6)	0.44 (11.1)
3/16	4	-TP-AN3	0.73 (18.5)	0.13 (3.2)	0.44 (11.1)
1/4	6	-TP-AN4	0.80 (20.3)	0.17 (4.4)	0.50 (12.7)
5/16	8	-TP-AN5	0.80 (20.3)	0.24 (6.0)	0.56 (14.3)
3/8	10	-TP-AN6	0.84 (21.3)	0.30 (7.5)	0.63 (15.9)
1/2	12	-TP-AN8	0.94 (23.9)	0.39 (9.9)	0.81 (20.6)
5/8	16	-TP-AN10	1.10 (27.9)	0.48 (12.3)	0.94 (23.8)
3/4	18	-TP-AN12	1.28 (32.5)	0.61 (15.5)	1.25 (31.7)
7/8	22	-TP-AN14	1.31 (33.3)	0.72 (18.3)	1.25 (31.8)
1	25	-TP-AN16	1.33 (33.8)	0.85 (21.5)	1.37 (34.9)
1 1/4	32	-TP-AN20	1.45 (36.8)	1.08 (27.5)	1.69 (42.9)
1 1/2	38	-TP-AN24	1.65 (41.9)	1.30 (33.0)	2.00 (50.8)
2	50	-TP-AN32	2.05 (52.1)	1.77 (45.0)	2.63 (66.7)

扩口阳螺纹弯头

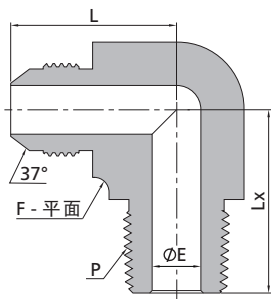

SAE 070202							
Tube 管外径		P-NPT 尺寸	基本订购号	尺寸, in. (mm)			
in.	mm			L	E	F	Lx
1/8	3	1/8	-LM-AN2-NS2	0.77 (19.6)	0.06 (1.6)	0.44 (11.1)	0.72 (18.3)
3/16	4	1/8	-LM-AN3-NS2	0.83 (21.1)	0.13 (3.2)	0.44 (11.1)	0.72 (18.3)
1/4	6	1/8	-LM-AN4-NS2	0.89 (22.6)	0.17 (4.4)	0.50 (12.7)	0.78 (19.8)
1/4	6	1/4	-LM-AN4-NS4	1.06 (26.9)	0.17 (4.4)	0.56 (14.3)	1.09 (27.7)
5/16	8	1/8	-LM-AN5-NS2	0.95 (24.1)	0.19 (4.8)	0.56 (14.3)	0.78 (19.8)
5/16	8	1/4	-LM-AN5-NS4	1.06 (26.9)	0.24 (6.0)	0.56 (14.3)	1.09 (27.7)
3/8	10	1/8	-LM-AN6-NS2	1.06 (26.9)	0.19 (4.8)	0.56 (14.3)	0.90 (22.8)
3/8	10	1/4	-LM-AN6-NS4	1.06 (26.9)	0.28 (7.1)	0.56 (14.3)	1.09 (27.7)
3/8	10	3/8	-LM-AN6-NS6	1.14 (29.0)	0.30 (7.5)	0.69 (17.5)	1.22 (31.0)
3/8	10	1/2	-LM-AN6-NS8	1.23 (31.2)	0.30 (7.5)	0.81 (20.6)	1.47 (37.3)
1/2	12	1/4	-LM-AN8-NS4	1.25 (31.8)	0.28 (7.1)	0.81 (20.6)	1.22 (31.0)
1/2	12	3/8	-LM-AN8-NS6	1.25 (31.8)	0.39 (9.9)	0.81 (20.6)	1.22 (31.0)
1/2	12	1/2	-LM-AN8-NS8	1.33 (33.7)	0.39 (9.9)	0.81 (20.6)	1.47 (37.3)
1/2	12	3/4	-LM-AN8-NS12	1.42 (36.0)	0.35 (9.0)	1.00 (25.4)	1.59 (40.4)
5/8	16	3/8	-LM-AN10-NS6	1.45 (36.8)	0.39 (9.9)	0.81 (20.6)	1.30 (33.0)
5/8	16	1/2	-LM-AN10-NS8	1.45 (36.8)	0.48 (12.3)	0.81 (20.6)	1.47 (37.3)
5/8	16	3/4	-LM-AN10-NS12	1.53 (38.9)	0.48 (12.3)	1.00 (25.4)	1.59 (40.4)
3/4	18	3/4	-LM-AN12-NS12	1.66 (42.2)	0.61 (15.5)	1.06 (27.0)	1.59 (40.4)
3/4	18	1	-LM-AN12-NS16	1.66 (42.2)	0.61 (15.5)	1.25 (31.8)	1.98 (50.4)
7/8	22	3/4	-LM-AN14-NS12	1.80 (45.7)	0.62 (15.7)	1.25 (31.8)	1.69 (42.9)
1	25	3/4	-LM-AN16-NS12	1.81 (46.0)	0.62 (15.7)	1.37 (34.9)	1.78 (45.2)
1	25	1	-LM-AN16-NS16	1.81 (46.0)	0.85 (21.5)	1.37 (34.9)	1.97 (50.0)
1 1/4	32	1	-LM-AN20-NS16	2.06 (52.3)	0.94 (23.8)	1.69 (42.9)	2.35 (59.6)
1 1/4	32	1 1/4	-LM-AN20-NS20	2.06 (52.3)	1.08 (27.5)	1.69 (42.9)	2.38 (60.5)

扩口阳螺纹位置可调弯头

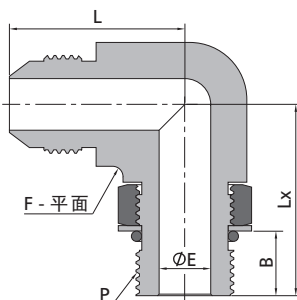

SAE 070220									
Tube 管外径		P-SAE 名义 尺寸	P-SAE/MS 螺纹 规格	基本订购号	尺寸, in. (mm)				
in.	mm				L	E	F	Lx	B
1/8	3	2	5/16-24	-LP-AN2-ST5	0.77 (19.6)	0.06 (1.6)	0.44 (11.1)	0.89 (22.6)	0.33 (8.4)
3/16	4	3	3/8-24	-LP-AN3-ST6	0.83 (21.1)	0.13 (3.2)	0.44 (11.1)	0.89 (22.6)	0.33 (8.4)
1/4	6	4	7/16-20	-LP-AN4-ST7	0.89 (22.6)	0.17 (4.4)	0.50 (12.7)	1.03 (26.2)	0.39 (9.8)
5/16	8	5	1/2-20	-LP-AN5-ST8	0.95 (24.1)	0.24 (6.0)	0.56 (14.3)	1.13 (28.7)	0.39 (9.8)
3/8	10	6	9/16-18	-LP-AN6-ST9	1.06 (26.9)	0.30 (7.5)	0.63 (15.9)	1.25 (31.8)	0.43 (11.0)
1/2	12	8	3/4-16	-LP-AN8-ST12	1.25 (31.8)	0.39 (9.9)	0.81 (20.6)	1.45 (36.8)	0.49 (12.5)
5/8	16	10	7/8-14	-LP-AN10-ST14	1.45 (36.8)	0.48 (12.3)	0.94 (23.8)	1.70 (43.2)	0.56 (14.2)
3/4	18	12	1 1/16-12	-LP-AN12-ST17	1.66 (42.2)	0.61 (15.5)	1.25 (31.8)	1.94 (49.3)	0.65 (16.5)
7/8	22	14	1 3/16-12	-LP-AN14-ST19	1.80 (45.7)	0.72 (18.3)	1.25 (31.8)	2.00 (50.8)	0.65 (16.5)
1	25	16	1 5/16-12	-LP-AN16-ST21	1.81 (46.0)	0.85 (21.5)	1.37 (34.9)	2.05 (52.1)	0.65 (16.5)
1 1/4	32	20	1 5/8-12	-LP-AN20-ST26	2.06 (52.3)	1.08 (27.5)	1.69 (42.9)	2.25 (57.2)	0.65 (16.5)
1 1/2	38	24	1 7/8-12	-LP-AN24-ST30	2.33 (59.2)	1.30 (33.0)	2.00 (50.8)	2.39 (60.7)	0.65 (16.5)

扩口阳螺纹 45° 弯头

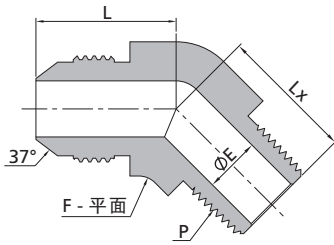

SAE 070302

Tube 管外径		P-NPT 尺寸	基本订购号	尺寸, in. (mm)			
in.	mm			L	E	F	Lx
1/8	3	1/8	-VM-AN2-NS2	0.69 (17.5)	0.06 (1.6)	0.44 (11.1)	0.52 (13.2)
3/16	4	1/8	-VM-AN3-NS2	0.69 (17.5)	0.13 (3.2)	0.44 (11.1)	0.52 (13.2)
1/4	6	1/8	-VM-AN4-NS2	0.72 (18.3)	0.17 (4.4)	0.50 (12.7)	0.64 (16.3)
5/16	8	1/8	-VM-AN5-NS2	0.77 (19.6)	0.19 (4.8)	0.56 (14.3)	0.64 (16.3)
3/8	10	1/4	-VM-AN6-NS4	0.83 (21.1)	0.28 (7.1)	0.56 (14.3)	0.86 (21.8)
1/2	12	3/8	-VM-AN8-NS6	0.98 (24.9)	0.39 (9.9)	0.69 (17.5)	0.95 (24.1)
5/8	16	1/2	-VM-AN10-NS8	1.11 (28.2)	0.48 (12.3)	0.81 (20.6)	1.17 (29.7)
3/4	18	3/4	-VM-AN12-NS12	1.28 (32.5)	0.61 (15.5)	1.06 (27.0)	1.20 (30.5)
7/8	22	3/4	-VM-AN14-NS12	1.42 (36.0)	0.72 (18.3)	1.25 (31.8)	1.30 (33.0)
1	25	1	-VM-AN16-NS16	1.47 (37.3)	0.85 (21.5)	1.37 (34.9)	1.48 (37.6)
1 1/2	38	1 1/2	-VM-AN24-NS24	1.78 (45.2)	1.30 (33.0)	2.00 (50.8)	1.77 (45.0)

扩口阴螺纹弯头

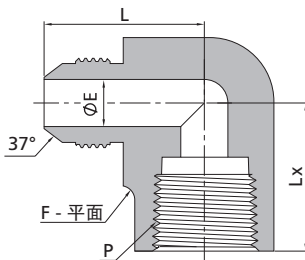

SAE 070203

Tube 管外径		P-NPT 尺寸	基本订购号	尺寸, in. (mm)			
in.	mm			L	E	F	Lx
1/8	3	1/8	-LF-AN2-NS2	1.00 (25.4)	0.06 (1.6)	0.56 (14.3)	0.66 (16.8)
3/16	4	1/8	-LF-AN3-NS2	1.03 (26.2)	0.13 (3.2)	0.56 (14.3)	0.66 (16.8)
1/4	6	1/8	-LF-AN4-NS2	1.08 (27.4)	0.17 (4.4)	0.56 (14.3)	0.66 (16.8)
1/4	6	1/4	-LF-AN4-NS4	1.22 (30.9)	0.17 (4.4)	0.81 (20.6)	0.94 (23.8)
5/16	8	1/8	-LF-AN5-NS2	1.08 (27.4)	0.24 (6.0)	0.56 (14.3)	0.66 (16.8)
5/16	8	1/4	-LF-AN5-NS4	1.22 (30.9)	0.24 (6.0)	0.81 (20.6)	0.94 (23.8)
3/8	10	1/8	-LF-AN6-NS2	1.06 (26.9)	0.30 (7.5)	0.63 (15.9)	0.66 (16.8)
3/8	10	1/4	-LF-AN6-NS4	1.23 (31.2)	0.30 (7.5)	0.81 (20.6)	0.94 (23.8)
3/8	10	3/8	-LF-AN6-NS6	1.31 (33.2)	0.30 (7.5)	0.94 (23.8)	1.02 (25.9)
1/2	12	1/4	-LF-AN8-NS4	1.24 (31.6)	0.39 (9.9)	0.81 (20.6)	0.94 (23.8)
1/2	12	3/8	-LF-AN8-NS6	1.42 (36.1)	0.39 (9.9)	0.94 (23.8)	1.02 (25.9)
1/2	12	1/2	-LF-AN8-NS8	1.42 (36.1)	0.39 (9.9)	1.06 (27.0)	1.23 (31.2)
5/8	16	1/2	-LF-AN10-NS8	1.64 (41.7)	0.48 (12.3)	1.06 (27.0)	1.23 (31.2)
3/4	18	1/2	-LF-AN12-NS8	1.66 (42.1)	0.61 (15.5)	1.25 (31.8)	1.23 (31.2)
3/4	18	3/4	-LF-AN12-NS12	1.89 (48.0)	0.61 (15.5)	1.37 (34.9)	1.36 (34.5)
7/8	22	3/4	-LF-AN14-NS12	1.86 (47.2)	0.72 (18.3)	1.37 (34.9)	1.42 (36.1)
1	25	1	-LF-AN16-NS16	2.17 (55.1)	0.85 (21.5)	1.69 (42.9)	1.62 (41.1)
1 1/4	32	1 1/4	-LF-AN20-NS20	2.33 (59.2)	1.08 (27.5)	2.00 (50.8)	1.70 (43.2)

扩口弯头

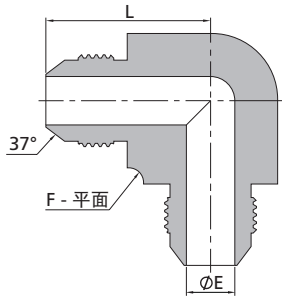

SAE 070201					
Tube 管外径		基本订购号	尺寸, in. (mm)		
in.	mm		L	E	F
1/8	3	-LU-AN2	0.77 (19.6)	0.06 (1.6)	0.44 (11.1)
3/16	4	-LU-AN3	0.83 (21.1)	0.13 (3.2)	0.44 (11.1)
1/4	6	-LU-AN4	0.89 (22.6)	0.17 (4.4)	0.50 (12.7)
5/16	8	-LU-AN5	0.95 (24.1)	0.24 (6.0)	0.56 (14.3)
3/8	10	-LU-AN6	1.06 (26.9)	0.30 (7.5)	0.56 (14.3)
1/2	12	-LU-AN8	1.25 (31.8)	0.39 (9.9)	0.81 (20.6)
5/8	16	-LU-AN10	1.45 (36.8)	0.48 (12.3)	0.81 (20.6)
3/4	18	-LU-AN12	1.66 (42.2)	0.61 (15.5)	1.06 (27.0)
7/8	22	-LU-AN14	1.80 (45.7)	0.72 (18.3)	1.25 (31.8)
1	25	-LU-AN16	1.81 (46.0)	0.85 (21.5)	1.37 (34.9)
1 1/4	32	-LU-AN20	2.06 (52.3)	1.08 (27.5)	1.69 (42.9)
1 1/2	38	-LU-AN24	2.33 (59.2)	1.30 (33.0)	2.00 (50.8)

扩口活接弯头

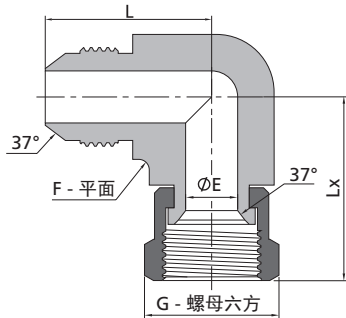

SAE 070221							
Tube 管外径		基本订购号	尺寸, in. (mm)				
in.	mm		L	E	F	Lx	G
1/8	3	-LU-AN2-AS2	0.77 (19.6)	0.06 (1.6)	0.44 (11.1)	0.97 (24.6)	0.44 (11.1)
3/16	4	-LU-AN3-AS3	0.83 (21.1)	0.13 (3.2)	0.44 (11.1)	1.00 (25.4)	0.50 (12.7)
1/4	6	-LU-AN4-AS4	0.89 (22.6)	0.17 (4.4)	0.50 (12.7)	1.00 (25.4)	0.56 (14.3)
5/16	8	-LU-AN5-AS5	0.95 (24.1)	0.24 (6.0)	0.56 (14.3)	1.06 (26.9)	0.63 (15.9)
3/8	10	-LU-AN6-AS6	1.06 (26.9)	0.30 (7.5)	0.56 (14.3)	1.25 (31.8)	0.69 (17.5)
1/2	12	-LU-AN8-AS8	1.25 (31.8)	0.39 (9.9)	0.81 (20.6)	1.38 (35.1)	0.87 (22.2)
5/8	16	-LU-AN10-AS10	1.45 (36.8)	0.48 (12.3)	0.81 (20.6)	1.62 (41.1)	1.00 (25.4)
3/4	18	-LU-AN12-AS12	1.66 (42.2)	0.61 (15.5)	1.06 (27.0)	1.75 (44.4)	1.25 (31.8)
7/8	22	-LU-AN14-AS14	1.80 (45.7)	0.72 (18.3)	1.25 (31.8)	1.78 (45.2)	1.37 (34.9)
1	25	-LU-AN16-AS16	1.81 (46.0)	0.85 (21.5)	1.37 (34.9)	2.00 (50.8)	1.50 (38.1)
1 1/4	32	-LU-AN20-AS20	2.06 (52.3)	1.08 (27.5)	1.69 (42.9)	2.31 (58.7)	2.00 (50.8)
1 1/2	38	-LU-AN24-AS24	2.33 (59.2)	1.30 (33.0)	2.00 (50.8)	2.59 (65.8)	2.37 (60.3)

支管阳螺纹扩口三通

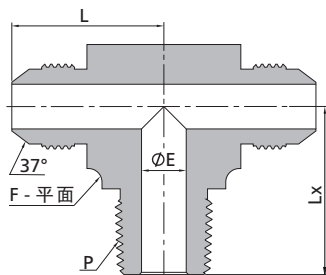

SAE 070425							
Tube 管外径		P-NPT 尺寸	基本订购号	尺寸, in. (mm)			
in.	mm			L	E	F	Lx
1/8	3	1/8	-TTM-AN2-NS2	0.77 (19.6)	0.06 (1.6)	0.44 (11.1)	0.72 (18.3)
3/16	4	1/8	-TTM-AN3-NS2	0.83 (21.1)	0.13 (3.2)	0.44 (11.1)	0.72 (18.3)
1/4	6	1/8	-TTM-AN4-NS2	0.89 (22.6)	0.17 (4.4)	0.50 (12.7)	0.78 (19.8)
1/4	6	1/4	-TTM-AN4-NS4	1.06 (26.9)	0.17 (4.4)	0.56 (14.3)	1.09 (27.7)
5/16	8	1/8	-TTM-AN5-NS2	0.95 (24.1)	0.19 (4.8)	0.56 (14.3)	0.78 (19.8)
5/16	8	1/4	-TTM-AN5-NS4	1.06 (26.9)	0.24 (6.0)	0.56 (14.3)	1.09 (27.7)
3/8	10	1/8	-TTM-AN6-NS2	1.06 (26.9)	0.19 (4.8)	0.56 (14.3)	0.90 (22.8)
3/8	10	1/4	-TTM-AN6-NS4	1.06 (26.9)	0.28 (7.1)	0.56 (14.3)	1.09 (27.7)
3/8	10	3/8	-TTM-AN6-NS6	1.14 (29.0)	0.30 (7.5)	0.69 (17.5)	1.22 (31.0)
3/8	10	1/2	-TTM-AN6-NS8	1.23 (31.2)	0.30 (7.5)	0.81 (20.6)	1.47 (37.3)
1/2	12	1/4	-TTM-AN8-NS4	1.25 (31.8)	0.28 (7.1)	0.81 (20.6)	1.22 (31.0)
1/2	12	3/8	-TTM-AN8-NS6	1.25 (31.8)	0.39 (9.9)	0.81 (20.6)	1.22 (31.0)
1/2	12	1/2	-TTM-AN8-NS8	1.33 (33.7)	0.39 (9.9)	0.81 (20.6)	1.47 (37.3)
1/2	12	3/4	-TTM-AN8-NS12	1.42 (36.0)	0.39 (9.9)	1.00 (25.4)	1.59 (40.4)
5/8	16	3/8	-TTM-AN10-NS6	1.45 (36.8)	0.39 (9.9)	0.81 (20.6)	1.30 (33.0)
5/8	16	1/2	-TTM-AN10-NS8	1.45 (36.8)	0.48 (12.3)	0.81 (20.6)	1.47 (37.3)
5/8	16	3/4	-TTM-AN10-NS12	1.53 (38.9)	0.48 (12.3)	1.00 (25.4)	1.59 (40.4)
3/4	18	3/4	-TTM-AN12-NS12	1.66 (42.2)	0.61 (15.5)	1.06 (27.0)	1.59 (40.4)
3/4	18	1	-TTM-AN12-NS16	1.66 (42.2)	0.61 (15.5)	1.25 (31.8)	1.98 (50.4)
7/8	22	3/4	-TTM-AN14-NS12	1.80 (45.7)	0.72 (18.3)	1.25 (31.8)	1.69 (42.9)
1	25	3/4	-TTM-AN16-NS12	1.81 (46.0)	0.72 (18.3)	1.37 (34.9)	1.78 (45.2)
1	25	1	-TTM-AN16-NS16	1.81 (46.0)	0.85 (21.5)	1.37 (34.9)	1.97 (50.0)
1 1/4	32	1	-TTM-AN20-NS16	2.06 (52.3)	0.94 (23.8)	1.69 (42.9)	2.35 (59.6)
1 1/4	32	1 1/4	-TTM-AN20-NS20	2.06 (52.3)	1.08 (27.5)	1.69 (42.9)	2.38 (60.5)

支管阳螺纹位置可调扩口三通

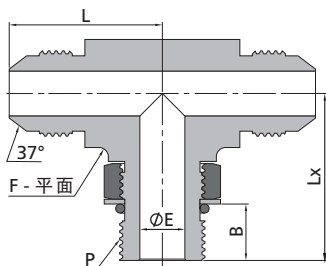

SAE 070429									
Tube 管外径		P-SAE P-SAE/MS 名义尺寸 螺纹规格		基本订购号	尺寸, in. (mm)				
in.	mm				L	E	F	Lx	B
1/8	3	2	5/16-24	-TTP-AN2-ST5	0.77 (19.6)	0.06 (1.6)	0.44 (11.1)	0.89 (22.6)	0.33 (8.4)
3/16	4	3	3/8-24	-TTP-AN3-ST6	0.83 (21.1)	0.13 (3.2)	0.44 (11.1)	0.89 (22.6)	0.33 (8.4)
1/4	6	4	7/16-20	-TTP-AN4-ST7	0.89 (22.6)	0.17 (4.4)	0.50 (12.7)	1.03 (26.2)	0.39 (9.8)
5/16	8	5	1/2-20	-TTP-AN5-ST8	0.95 (24.1)	0.24 (6.0)	0.56 (14.3)	1.13 (28.7)	0.39 (9.8)
3/8	10	6	9/16-18	-TTP-AN6-ST9	1.06 (26.9)	0.30 (7.5)	0.63 (15.9)	1.25 (31.8)	0.43 (11.0)
1/2	12	8	3/4-16	-TTP-AN8-ST12	1.25 (31.8)	0.39 (9.9)	0.81 (20.6)	1.45 (36.8)	0.49 (12.5)
5/8	16	10	7/8-14	-TTP-AN10-ST14	1.45 (36.8)	0.48 (12.3)	0.94 (23.8)	1.70 (43.2)	0.56 (14.2)
3/4	18	12	1 1/16-12	-TTP-AN12-ST17	1.66 (42.2)	0.61 (15.5)	1.25 (31.8)	1.94 (49.3)	0.65 (16.5)
7/8	22	14	1 3/16-12	-TTP-AN14-ST19	1.80 (45.7)	0.72 (18.3)	1.25 (31.8)	2.00 (50.8)	0.65 (16.5)
1	25	16	1 5/16-12	-TTP-AN16-ST21	1.81 (46.0)	0.85 (21.5)	1.37 (34.9)	2.05 (52.1)	0.65 (16.5)
1 1/4	32	20	1 5/8-12	-TTP-AN20-ST26	2.06 (52.3)	1.08 (27.5)	1.69 (42.9)	2.25 (57.2)	0.65 (16.5)
1 1/2	38	24	1 7/8-12	-TTP-AN24-ST30	2.33 (59.2)	1.30 (33.0)	2.00 (50.8)	2.39 (60.7)	0.65 (16.5)

主管阳螺纹扩口三通

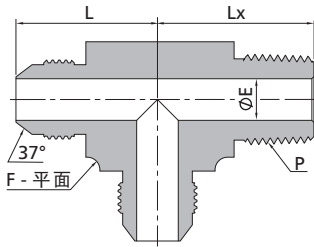

SAE 070424							
Tube 管外径		P-NPT 尺寸	基本订购号	尺寸, in. (mm)			
in.	mm			L	E	F	Lx
1/8	3	1/8	-TMT-AN2-NS2	0.77 (19.6)	0.06 (1.6)	0.44 (11.1)	0.72 (18.3)
3/16	4	1/8	-TMT-AN3-NS2	0.83 (21.1)	0.13 (3.2)	0.44 (11.1)	0.72 (18.3)
1/4	6	1/8	-TMT-AN4-NS2	0.89 (22.6)	0.17 (4.4)	0.50 (12.7)	0.78 (19.8)
1/4	6	1/4	-TMT-AN4-NS4	1.06 (26.9)	0.17 (4.4)	0.56 (14.3)	1.09 (27.7)
5/16	8	1/8	-TMT-AN5-NS2	0.95 (24.1)	0.19 (4.8)	0.56 (14.3)	0.78 (19.8)
5/16	8	1/4	-TMT-AN5-NS4	1.06 (26.9)	0.24 (6.0)	0.56 (14.3)	1.09 (27.7)
3/8	10	1/8	-TMT-AN6-NS2	1.06 (26.9)	0.19 (4.8)	0.56 (14.3)	0.90 (22.8)
3/8	10	1/4	-TMT-AN6-NS4	1.06 (26.9)	0.28 (7.1)	0.56 (14.3)	1.09 (27.7)
3/8	10	3/8	-TMT-AN6-NS6	1.14 (29.0)	0.30 (7.5)	0.69 (17.5)	1.22 (31.0)
3/8	10	1/2	-TMT-AN6-NS8	1.23 (31.2)	0.30 (7.5)	0.81 (20.6)	1.47 (37.3)
1/2	12	1/4	-TMT-AN8-NS4	1.25 (31.8)	0.28 (7.1)	0.81 (20.6)	1.22 (31.0)
1/2	12	3/8	-TMT-AN8-NS6	1.25 (31.8)	0.39 (9.9)	0.81 (20.6)	1.22 (31.0)
1/2	12	1/2	-TMT-AN8-NS8	1.33 (33.7)	0.39 (9.9)	0.81 (20.6)	1.47 (37.3)
1/2	12	3/4	-TMT-AN8-NS12	1.42 (36.0)	0.39 (9.9)	1.00 (25.4)	1.59 (40.4)
5/8	16	3/8	-TMT-AN10-NS6	1.45 (36.8)	0.39 (9.9)	0.81 (20.6)	1.30 (33.0)
5/8	16	1/2	-TMT-AN10-NS8	1.45 (36.8)	0.48 (12.3)	0.81 (20.6)	1.47 (37.3)
5/8	16	3/4	-TMT-AN10-NS12	1.53 (38.9)	0.48 (12.3)	1.00 (25.4)	1.59 (40.4)
3/4	18	3/4	-TMT-AN12-NS12	1.66 (42.2)	0.61 (15.5)	1.06 (27.0)	1.59 (40.4)
3/4	18	1	-TMT-AN12-NS16	1.66 (42.2)	0.61 (15.5)	1.25 (31.8)	1.98 (50.4)
7/8	22	3/4	-TMT-AN14-NS12	1.80 (45.7)	0.72 (18.3)	1.25 (31.8)	1.69 (42.9)
1	25	3/4	-TMT-AN16-NS12	1.81 (46.0)	0.72 (18.3)	1.37 (34.9)	1.78 (45.2)
1	25	1	-TMT-AN16-NS16	1.81 (46.0)	0.85 (21.5)	1.37 (34.9)	1.97 (50.0)
1 1/4	32	1	-TMT-AN20-NS16	2.06 (52.3)	0.94 (23.8)	1.69 (42.9)	2.35 (59.6)
1 1/4	32	1 1/4	-TMT-AN20-NS20	2.06 (52.3)	1.08 (27.5)	1.69 (42.9)	2.38 (60.5)

支管阴螺纹扩口三通

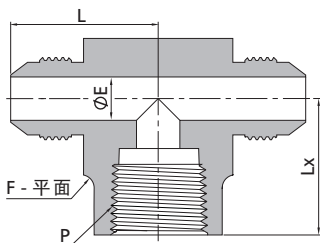

SAE 070427							
Tube 管外径		P-NPT 尺寸	基本订购号	尺寸, in. (mm)			
in.	mm			L	E	F	Lx
1/8	3	1/8	-TTF-AN2-NS2	1.00 (25.4)	0.06 (1.6)	0.56 (14.3)	0.66 (16.8)
3/16	4	1/8	-TTF-AN3-NS2	1.03 (26.2)	0.13 (3.2)	0.56 (14.3)	0.66 (16.8)
1/4	6	1/8	-TTF-AN4-NS2	1.08 (27.4)	0.17 (4.4)	0.56 (14.3)	0.66 (16.8)
1/4	6	1/4	-TTF-AN4-NS4	1.22 (30.9)	0.17 (4.4)	0.81 (20.6)	0.94 (23.8)
5/16	8	1/8	-TTF-AN5-NS2	1.08 (27.4)	0.24 (6.0)	0.56 (14.3)	0.66 (16.8)
5/16	8	1/4	-TTF-AN5-NS4	1.22 (30.9)	0.24 (6.0)	0.81 (20.6)	0.94 (23.8)
3/8	10	1/8	-TTF-AN6-NS2	1.06 (26.9)	0.30 (7.5)	0.63 (15.9)	0.66 (16.8)
3/8	10	1/4	-TTF-AN6-NS4	1.23 (31.2)	0.30 (7.5)	0.81 (20.6)	0.94 (23.8)
3/8	10	3/8	-TTF-AN6-NS6	1.31 (33.2)	0.30 (7.5)	0.94 (23.8)	1.02 (25.9)
1/2	12	1/4	-TTF-AN8-NS4	1.24 (31.6)	0.39 (9.9)	0.81 (20.6)	0.94 (23.8)
1/2	12	3/8	-TTF-AN8-NS6	1.42 (36.1)	0.39 (9.9)	0.94 (23.8)	1.02 (25.9)
1/2	12	1/2	-TTF-AN8-NS8	1.42 (36.1)	0.39 (9.9)	1.06 (27.0)	1.23 (31.2)
5/8	16	1/2	-TTF-AN10-NS8	1.64 (41.7)	0.48 (12.3)	1.06 (27.0)	1.23 (31.2)
3/4	18	1/2	-TTF-AN12-NS8	1.66 (42.1)	0.61 (15.5)	1.25 (31.8)	1.23 (31.2)
3/4	18	3/4	-TTF-AN12-NS12	1.89 (48.0)	0.61 (15.5)	1.37 (34.9)	1.36 (34.5)
7/8	22	3/4	-TTF-AN14-NS12	1.86 (47.2)	0.72 (18.3)	1.37 (34.9)	1.42 (36.1)
1	25	1	-TTF-AN16-NS16	2.17 (55.1)	0.85 (21.5)	1.69 (42.9)	1.62 (41.1)
1 1/4	32	1 1/4	-TTF-AN20-NS20	2.33 (59.2)	1.08 (27.5)	2.00 (50.8)	1.70 (43.2)

主管阴螺纹扩口三通

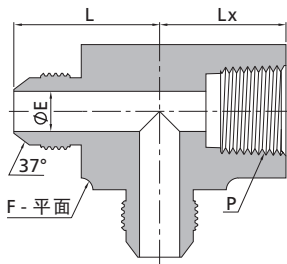

SAE 070426

Tube 管外径		P-NPT 尺寸	基本订购号	尺寸, in. (mm)			
in.	mm			L	E	F	Lx
1/8	3	1/8	-TFT-AN2-NS2	1.00 (25.4)	0.06 (1.6)	0.56 (14.3)	0.66 (16.8)
3/16	4	1/8	-TFT-AN3-NS2	1.03 (26.2)	0.13 (3.2)	0.56 (14.3)	0.66 (16.8)
1/4	6	1/8	-TFT-AN4-NS2	1.08 (27.4)	0.17 (4.4)	0.56 (14.3)	0.66 (16.8)
1/4	6	1/4	-TFT-AN4-NS4	1.22 (30.9)	0.17 (4.4)	0.81 (20.6)	0.94 (23.8)
5/16	8	1/8	-TFT-AN5-NS2	1.08 (27.4)	0.24 (6.0)	0.56 (14.3)	0.66 (16.8)
5/16	8	1/4	-TFT-AN5-NS4	1.22 (30.9)	0.24 (6.0)	0.81 (20.6)	0.94 (23.8)
3/8	10	1/8	-TFT-AN6-NS2	1.06 (26.9)	0.30 (7.5)	0.63 (15.9)	0.66 (16.8)
3/8	10	1/4	-TFT-AN6-NS4	1.23 (31.2)	0.30 (7.5)	0.81 (20.6)	0.94 (23.8)
3/8	10	3/8	-TFT-AN6-NS6	1.31 (33.2)	0.30 (7.5)	0.94 (23.8)	1.02 (25.9)
1/2	12	1/4	-TFT-AN8-NS4	1.24 (31.6)	0.39 (9.9)	0.81 (20.6)	0.94 (23.8)
1/2	12	3/8	-TFT-AN8-NS6	1.42 (36.1)	0.39 (9.9)	0.94 (23.8)	1.02 (25.9)
1/2	12	1/2	-TFT-AN8-NS8	1.42 (36.1)	0.39 (9.9)	1.06 (27.0)	1.23 (31.2)
5/8	16	1/2	-TFT-AN10-NS8	1.64 (41.7)	0.48 (12.3)	1.06 (27.0)	1.23 (31.2)
3/4	18	1/2	-TFT-AN12-NS8	1.66 (42.1)	0.61 (15.5)	1.25 (31.8)	1.23 (31.2)
3/4	18	3/4	-TFT-AN12-NS12	1.89 (48.0)	0.61 (15.5)	1.37 (34.9)	1.36 (34.5)
7/8	22	3/4	-TFT-AN14-NS12	1.86 (47.2)	0.72 (18.3)	1.37 (34.9)	1.42 (36.1)
1	25	1	-TFT-AN16-NS16	2.17 (55.1)	0.85 (21.5)	1.69 (42.9)	1.62 (41.1)
1 1/4	32	1 1/4	-TFT-AN20-NS20	2.33 (59.2)	1.08 (27.5)	2.00 (50.8)	1.70 (43.2)

扩口三通

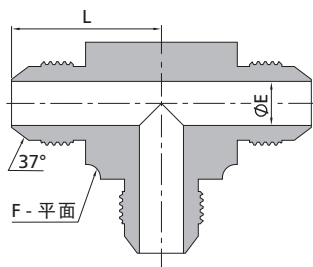

SAE 070401

Tube 管外径		基本订购号	尺寸, in. (mm)		
in.	mm		L	E	F
1/8	3	-TTT-AN2	0.77 (19.6)	0.06 (1.6)	0.44 (11.1)
3/16	4	-TTT-AN3	0.83 (21.1)	0.13 (3.2)	0.44 (11.1)
1/4	6	-TTT-AN4	0.89 (22.6)	0.17 (4.4)	0.50 (12.7)
5/16	8	-TTT-AN5	0.95 (24.1)	0.24 (6.0)	0.56 (14.3)
3/8	10	-TTT-AN6	1.06 (26.9)	0.30 (7.5)	0.56 (14.3)
1/2	12	-TTT-AN8	1.25 (31.8)	0.39 (9.9)	0.81 (20.6)
5/8	16	-TTT-AN10	1.45 (36.8)	0.48 (12.3)	0.81 (20.6)
3/4	18	-TTT-AN12	1.66 (42.2)	0.61 (15.5)	1.06 (27.0)
7/8	22	-TTT-AN14	1.80 (45.7)	0.72 (18.3)	1.25 (31.8)
1	25	-TTT-AN16	1.81 (46.0)	0.85 (21.5)	1.37 (34.9)
1 1/4	32	-TTT-AN20	2.06 (52.3)	1.08 (27.5)	1.69 (42.9)
1 1/2	38	-TTT-AN24	2.33 (59.2)	1.30 (33.0)	2.00 (50.8)

主管活接扩口三通

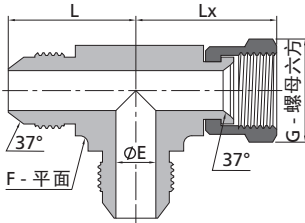

SAE 070432

Tube 管外径		基本订购号	尺寸, in. (mm)				
in.	mm		L	E	F	Lx	G
1/8	3	-TTT-AN2-AS2-AN2	0.77 (19.6)	0.06 (1.6)	0.44 (11.1)	0.97 (24.6)	0.44 (11.1)
3/16	4	-TTT-AN3-AS3-AN3	0.83 (21.1)	0.13 (3.2)	0.44 (11.1)	1.00 (25.4)	0.50 (12.7)
1/4	6	-TTT-AN4-AS4-AN4	0.89 (22.6)	0.17 (4.4)	0.50 (12.7)	1.00 (25.4)	0.56 (14.3)
5/16	8	-TTT-AN5-AS5-AN5	0.95 (24.1)	0.24 (6.0)	0.56 (14.3)	1.06 (26.9)	0.63 (15.9)
3/8	10	-TTT-AN6-AS6-AN6	1.06 (26.9)	0.30 (7.5)	0.56 (14.3)	1.25 (31.8)	0.69 (17.5)
1/2	12	-TTT-AN8-AS8-AN8	1.25 (31.8)	0.39 (9.9)	0.81 (20.6)	1.38 (35.1)	0.87 (22.2)
5/8	16	-TTT-AN10-AS10-AN10	1.45 (36.8)	0.48 (12.3)	0.81 (20.6)	1.62 (41.1)	1.00 (25.4)
3/4	18	-TTT-AN12-AS12-AN12	1.66 (42.2)	0.61 (15.5)	1.06 (27.0)	1.75 (44.4)	1.25 (31.8)
7/8	22	-TTT-AN14-AS14-AN14	1.80 (45.7)	0.72 (18.3)	1.25 (31.8)	1.78 (45.2)	1.37 (34.9)
1	25	-TTT-AN16-AS16-AN16	1.81 (46.0)	0.85 (21.5)	1.37 (34.9)	2.00 (50.8)	1.50 (38.1)
1 1/4	32	-TTT-AN20-AS20-AN20	2.06 (52.3)	1.08 (27.5)	1.69 (42.9)	2.31 (58.7)	2.00 (50.8)
1 1/2	38	-TTT-AN24-AS24-AN24	2.33 (59.2)	1.30 (33.0)	2.00 (50.8)	2.59 (65.8)	2.37 (60.3)

支管活接扩口三通

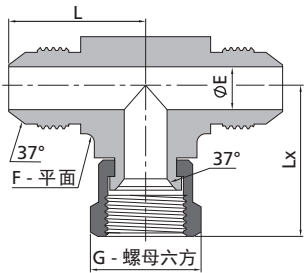

SAE 070433

Tube 管外径		基本订购号	尺寸, in. (mm)				
in.	mm		L	E	F	Lx	G
1/8	3	-TTT-AN2-AN2-AS2	0.77 (19.6)	0.06 (1.6)	0.44 (11.1)	0.97 (24.6)	0.44 (11.1)
3/16	4	-TTT-AN3-AN3-AS3	0.83 (21.1)	0.13 (3.2)	0.44 (11.1)	1.00 (25.4)	0.50 (12.7)
1/4	6	-TTT-AN4-AN4-AS4	0.89 (22.6)	0.17 (4.4)	0.50 (12.7)	1.00 (25.4)	0.56 (14.3)
5/16	8	-TTT-AN5-AN5-AS5	0.95 (24.1)	0.24 (6.0)	0.56 (14.3)	1.06 (26.9)	0.63 (15.9)
3/8	10	-TTT-AN6-AN6-AS6	1.06 (26.9)	0.30 (7.5)	0.56 (14.3)	1.25 (31.8)	0.69 (17.5)
1/2	12	-TTT-AN8-AN8-AS8	1.25 (31.8)	0.39 (9.9)	0.81 (20.6)	1.38 (35.1)	0.87 (22.2)
5/8	16	-TTT-AN10-AN10-AS10	1.45 (36.8)	0.48 (12.3)	0.81 (20.6)	1.62 (41.1)	1.00 (25.4)
3/4	18	-TTT-AN12-AN12-AS12	1.66 (42.2)	0.61 (15.5)	1.06 (27.0)	1.75 (44.4)	1.25 (31.8)
7/8	22	-TTT-AN14-AN14-AS14	1.80 (45.7)	0.72 (18.3)	1.25 (31.8)	1.78 (45.2)	1.37 (34.9)
1	25	-TTT-AN16-AN16-AS16	1.81 (46.0)	0.85 (21.5)	1.37 (34.9)	2.00 (50.8)	1.50 (38.1)
1 1/4	32	-TTT-AN20-AN20-AS20	2.06 (52.3)	1.08 (27.5)	1.69 (42.9)	2.31 (58.7)	2.00 (50.8)
1 1/2	38	-TTT-AN24-AN24-AS24	2.33 (59.2)	1.30 (33.0)	2.00 (50.8)	2.59 (65.8)	2.37 (60.3)

扩口四通

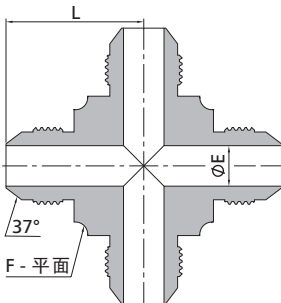

SAE 070501

Tube 管外径		基本订购号	尺寸, in. (mm)		
in.	mm		L	E	F
1/8	3	-C-AN2	0.77 (19.6)	0.06 (1.6)	0.44 (11.1)
3/16	4	-C-AN3	0.83 (21.1)	0.13 (3.2)	0.44 (11.1)
1/4	6	-C-AN4	0.89 (22.6)	0.17 (4.4)	0.50 (12.7)
5/16	8	-C-AN5	0.95 (24.1)	0.24 (6.0)	0.56 (14.3)
3/8	10	-C-AN6	1.06 (26.9)	0.30 (7.5)	0.56 (14.3)
1/2	12	-C-AN8	1.25 (31.8)	0.39 (9.9)	0.81 (20.6)
5/8	16	-C-AN10	1.45 (36.8)	0.48 (12.3)	0.81 (20.6)
3/4	18	-C-AN12	1.78 (45.2)	0.61 (15.5)	1.25 (31.8)
7/8	22	-C-AN14	1.80 (45.7)	0.72 (18.3)	1.25 (31.8)
1	25	-C-AN16	2.02 (51.2)	0.85 (21.5)	1.69 (42.9)
1 1/4	32	-C-AN20	2.06 (52.3)	1.08 (27.5)	1.69 (42.9)

info@fitok.com
www.fitok.com

FK-IC-GF-04-ZH-240710